

ATLAS Barrel Alignment

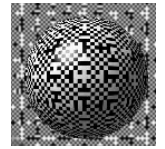

Hardware Setup (1)

Cavern

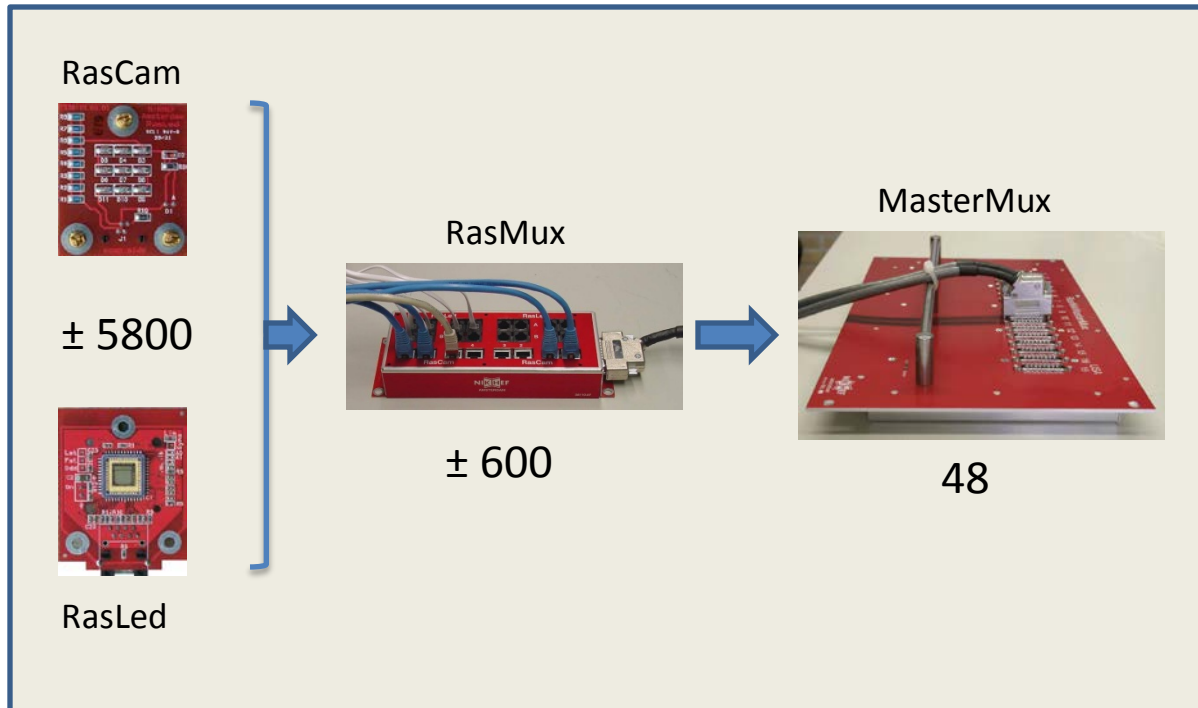

USA15

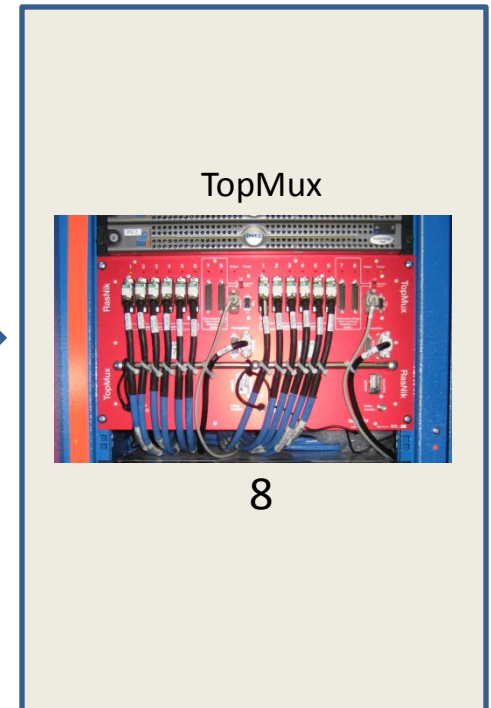

ATLAS Barrel Alignment

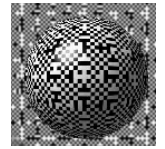

Hardware Setup (2)

December 5 2005



Rack: Y.28-19.A1

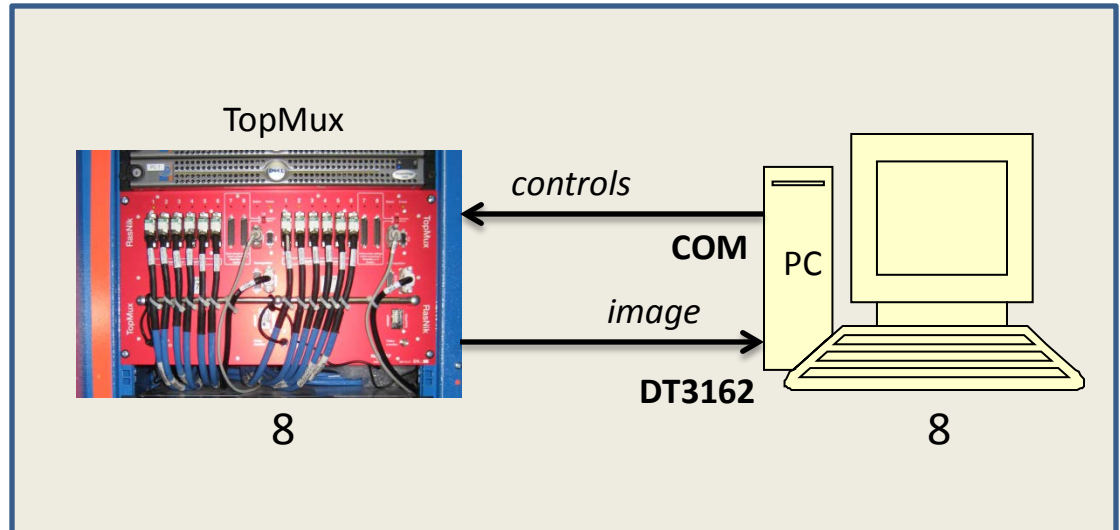

USA15

ATLAS Barrel Alignment

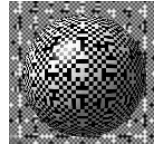

Critical components

PC: Dell PE750

- Rack mountable, 1U
- 3.2 GHz, 1 GB RAM, 80 GB harddisk
- Windows XP
- PCI-bus: 5 Volt
- 8 PCs operational since Dec 2005 ★
- Spares: 4
- Enough fans and disks

Frame-grabber: DT3162

- Manufacturer: Data Translation
- technically the perfect grabber
- DT: stopped frame-grabber production
- driver not supported anymore (up to WXP) ★
- PCI device: 5 Volt ★
- no alternatives (frame-grabber market vanished)
- Spares: 10

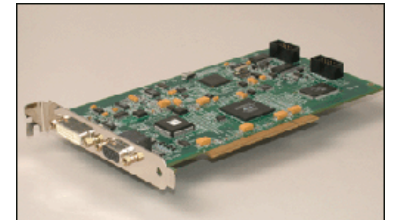

Multiplexing Scheme

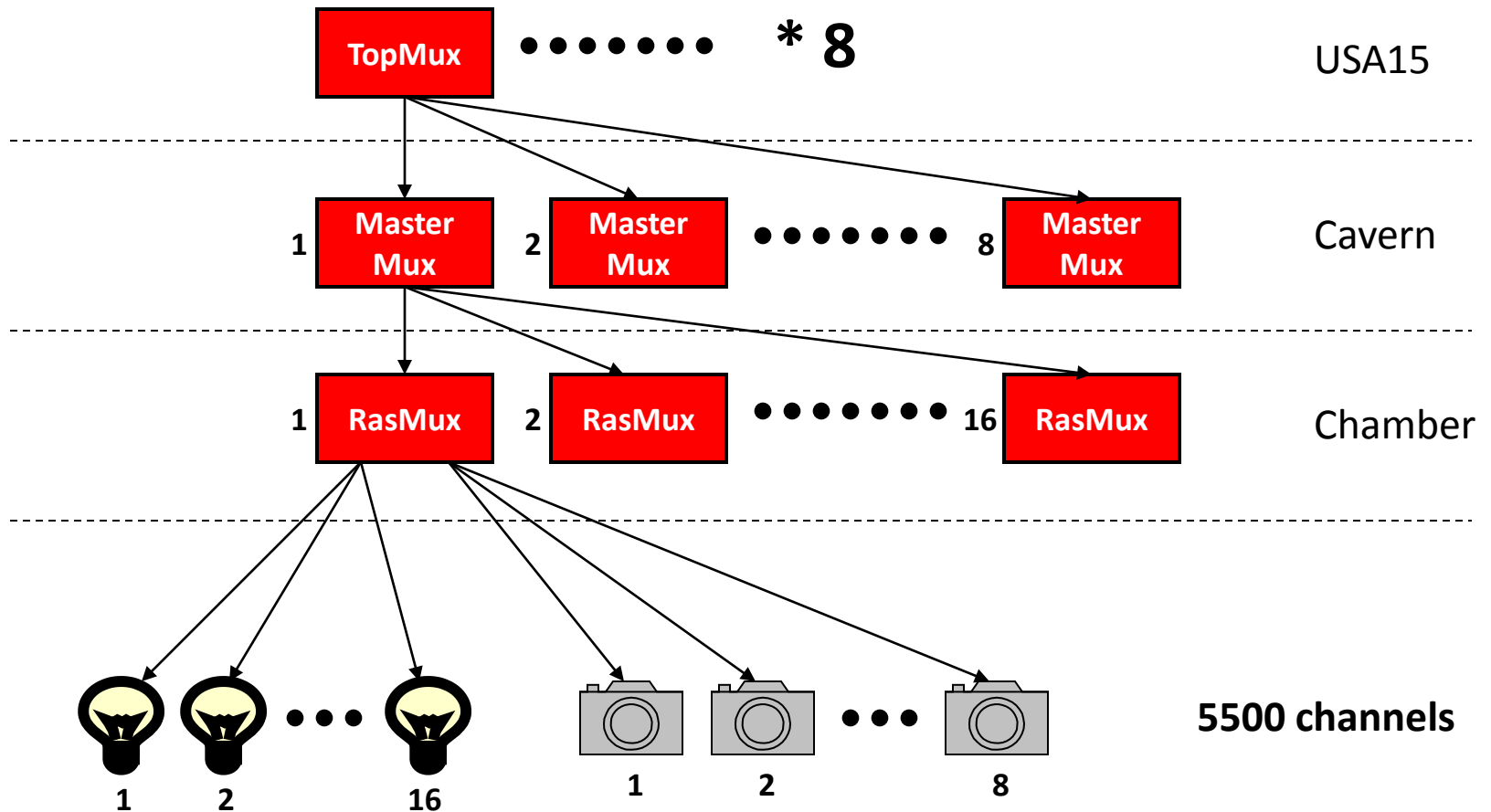
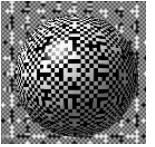

Rasdim

